

Fernvale DVT-1

U1_02connectors
02connectors_SchDoc



U1_03kaps
03kaps_SchDoc



U1_04kaps general
04kaps general_SchDoc

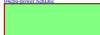

Copyrights: CC-BY-SA 3.0 Patents: Apache 2.0
Copyright 2014 Andrew "bunnie" Huang

Title		
Fernvale DVT-1		
Size	Number	Revision
A0		
Date	2/24/2014	Sheet of
File	F:\projects\Fernvale\02_connectors_SchDoc	Drawn By



Truncated Arduino header

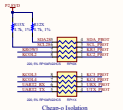

Cheap-o-Isolation

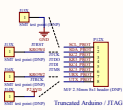

Truncated Arduino / JTAG (short TP to header for JTAG)

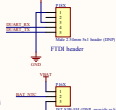

Li-Ion battery

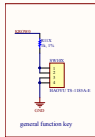

general function key

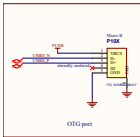

OTG port

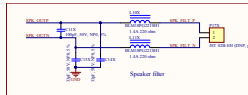

Speaker filter

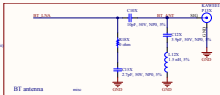

BT antenna

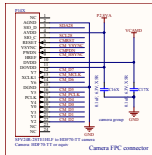

Camera FPC connector

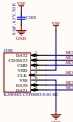

SD memory card

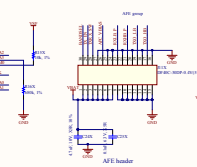

AFE header

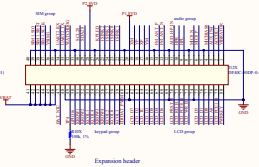

Expansion header



Copyright: CC-BY-SA 3.0 Patents Apache 2.0
Copyright 2014 Andrew "hummie" Huang

Female DVI-I	
Pin	Signal
1	Shield
2	Shield
3	Shield
4	Shield
5	Shield
6	Shield
7	Shield
8	Shield
9	Shield
10	Shield
11	Shield
12	Shield
13	Shield
14	Shield
15	Shield
16	Shield
17	Shield
18	Shield
19	Shield
20	Shield
21	Shield
22	Shield
23	Shield
24	Shield
25	Shield
26	Shield
27	Shield
28	Shield
29	Shield
30	Shield
31	Shield
32	Shield
33	Shield
34	Shield
35	Shield
36	Shield
37	Shield
38	Shield
39	Shield
40	Shield
41	Shield
42	Shield
43	Shield
44	Shield
45	Shield
46	Shield
47	Shield
48	Shield
49	Shield
50	Shield
51	Shield
52	Shield
53	Shield
54	Shield
55	Shield
56	Shield
57	Shield
58	Shield
59	Shield
60	Shield
61	Shield
62	Shield
63	Shield
64	Shield
65	Shield
66	Shield
67	Shield
68	Shield
69	Shield
70	Shield
71	Shield
72	Shield
73	Shield
74	Shield
75	Shield
76	Shield
77	Shield
78	Shield
79	Shield
80	Shield
81	Shield
82	Shield
83	Shield
84	Shield
85	Shield
86	Shield
87	Shield
88	Shield
89	Shield
90	Shield
91	Shield
92	Shield
93	Shield
94	Shield
95	Shield
96	Shield
97	Shield
98	Shield
99	Shield
100	Shield

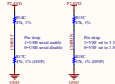
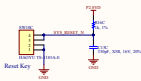
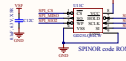
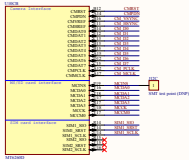
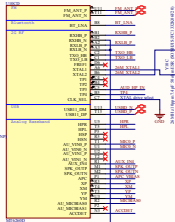
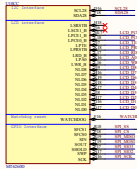
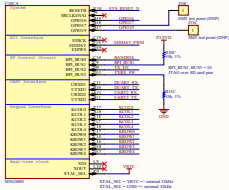

 Copyright CC-BY-SA 3.0
 Copyright 2014 Andrew "bunnie" Huang

Revision DVT-1	
Rev	1
Date	
Author	
Checked by	
Approved by	

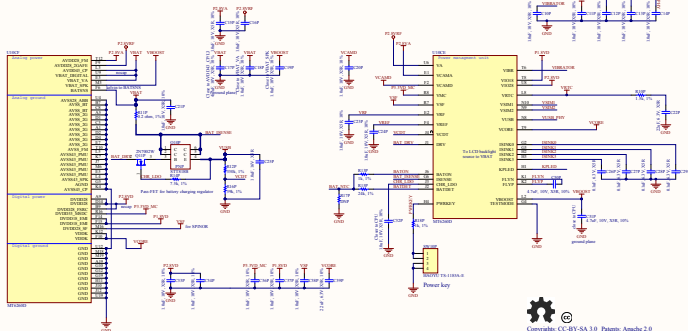

Copyright: CC-BY-SA 3.0 Patricio Apache 2.0
Copyright 2014 Andrew "bramir" Huang

Ferretale DVT-1

Rev	Description	Author	Date
1	Initial Release	Andrew "bramir" Huang	2014-08-01
2	Minor updates	Andrew "bramir" Huang	2014-08-01
3	Minor updates	Andrew "bramir" Huang	2014-08-01
4	Minor updates	Andrew "bramir" Huang	2014-08-01
5	Minor updates	Andrew "bramir" Huang	2014-08-01
6	Minor updates	Andrew "bramir" Huang	2014-08-01
7	Minor updates	Andrew "bramir" Huang	2014-08-01
8	Minor updates	Andrew "bramir" Huang	2014-08-01
9	Minor updates	Andrew "bramir" Huang	2014-08-01
10	Minor updates	Andrew "bramir" Huang	2014-08-01